

20
23
collection

ELONE

BATHROOM ACCESSORIES

www.elonebanyo.com

ELONE

BATHROOM ACCESSORIES



İçindekiler

Index

Yavaş Kapanan Klozet Kapakları	1
Soft Close Seat Covers	
Duroplast Klozet Kapakları	5
Duroplast Seat Covers	
Thermoplast Klozet Kapakları	10
Thermoplast Seat Covers	
Gömme Rezervuarlar	14
Concealed Cistern	
Rezervuar İç Takımlar	15
Internal Mechanisms	
Flatörler	17
Fill-Valve	
Ara Kesmeler	18
Stop Valve	
Yardımcı Malzemeler	19
Auxiliary Materials	
Yer Sifonları	21
Floor Drains	
Duş Kanalları	22
Mono Block	
Banyo Aksesuarları	24
Bathroom Accessories	



Yavaş Kapanan Klozet Kapağı Soft Close Seat Cover



INOVA SOFT

Kod Code	INOV0101151001
Açıklama Description	Duroplast SLIM Örtme Düğmeli Yavaş Kapanan Klozet Kapağı Duroplast SLIM WRAP-OVER with Button Quick Release Soft Close Seat Cover
Renk Color	Beyaz White
Menteşe Hinge	Düğmeli Paslanmaz Krom Metal Stainless Steel
Bağlama Şekli Fixation Type	Üst Top
Koli Adedi Box Qty.	10 Adet 10 Pcs

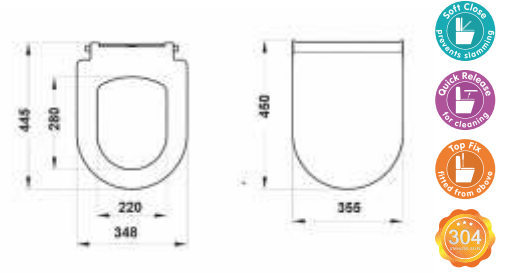

Yavaş Kapanan Klozet Kapağı Soft Close Seat Cover



QUBE SOFT

Kod Code	QUBE0101141001
Açıklama Description	Duroplast SLIM Tak-Çıkar Yavaş Kapanan Klozet Kapağı Duroplast SLIM Quick Release Soft Close Seat Cover
Renk Color	Beyaz White
Menteşe Hinge	Paslanmaz Krom Metal Stainless Steel
Bağlama Şekli Fixation Type	Üst Top
Koli Adedi Box Qty.	10 Adet 10 Pcs

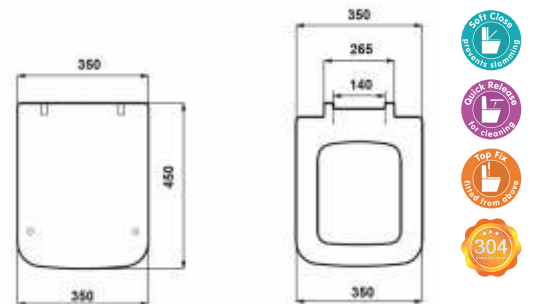

Yavaş Kapanan Klozet Kapağı Soft Close Seat Cover

NEW



WHITE



675.00₺

BLACK



1050.00₺

RED



1050.00₺

MATTE



1350.00₺

S.COLORS



1400.00₺

INCA SOFT

Kod Code	INCA0101151001
Açıklama Description	Duroplast SLIM Düğmeli Yavaş Kapanan Klozet Kapağı Duroplast SLIM with Button Quick Release Soft Close Seat Cover
Renk Color	Beyaz White
Menteşe Hinge	Düğmeli Paslanmaz Krom Metal Stainless Steel
Bağlama Şekli Fixation Type	Üst Top
Koli Adedi Box Qty.	10 Adet 10 Pcs

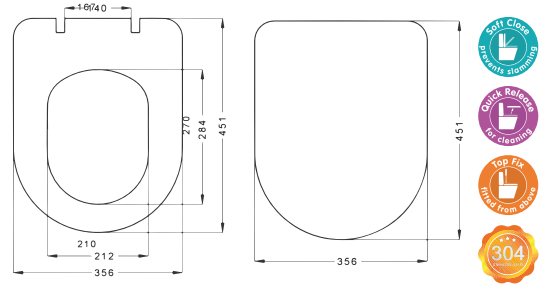

Yavaş Kapanan Klozet Kapağı Soft Close Seat Cover

NEW



WHITE



675.00₺

BLACK



1050.00₺

RED



1050.00₺

MATTE



1350.00₺

S.COLORS



1400.00₺

QUATRO SOFT

Kod Code	QUAT010151001
Açıklama Description	Duroplast SLIM Örtme Düğmeli Yavaş Kapanan Klozet Kapağı Duroplast SLIM WRAP-OVER with Button Quick Release Soft Close Seat Cover
Renk Color	Beyaz White
Menteşe Hinge	Düğmeli Paslanmaz Krom Metal Stainless Steel
Bağlama Şekli Fixation Type	Üst Top
Koli Adedi Box Qty.	10 Adet 10 Pcs

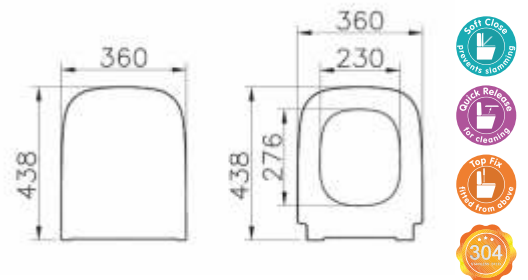

Yavaş Kapanan Klozet Kapağı Soft Close Seat Cover

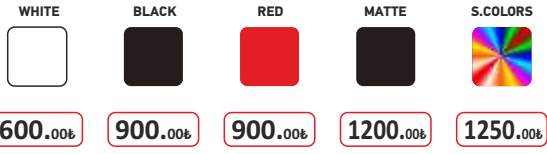

GALA PRESTIJ SOFT

Kod Code	GAPJ0101141001
Açıklama Description	Duroplast Örtme Tak-Çıkar Yavaş Kapanan Klozet Kapağı Duroplast Wrap-Over Quick Release Soft Close Seat Cover
Renk Color	Beyaz White
Menteşe Hinge	Paslanmaz Krom Metal Stainless Steel
Bağlama Şekli Fixation Type	Üst Top
Koli Adedi Box Qty.	10 Adet 10 Pcs

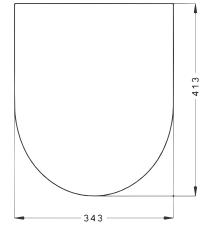
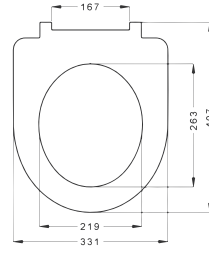

Yavaş Kapanan Klozet Kapağı Soft Close Seat Cover

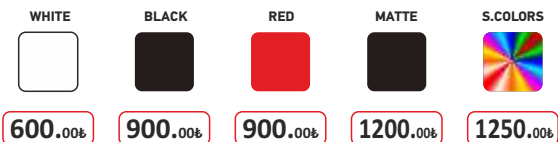

GALA PREMIUM SOFT

Kod Code	GAPR0101141001
Açıklama Description	Duroplast SLIM Tak-Çıkar Yavaş Kapanan Klozet Kapağı Duroplast SLIM Quick Release Soft Close Seat Cover
Renk Color	Beyaz White
Menteşe Hinge	Paslanmaz Krom Metal Stainless Steel
Bağlama Şekli Fixation Type	Üst Top
Koli Adedi Box Qty.	10 Adet 10 Pcs

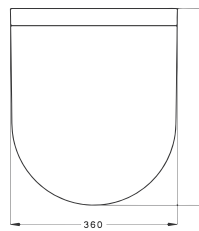
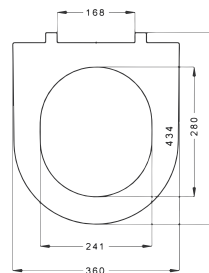

Yavaş Kapanan Klozet Kapağı Soft Close Seat Cover

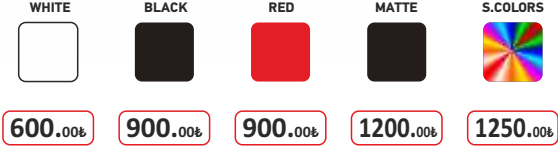

Yavaş Kapanan Klozet Kapağı Soft Close Seat Cover

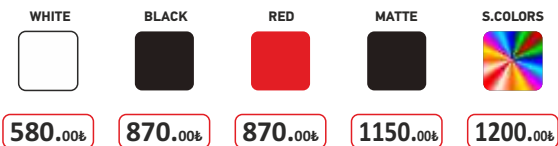

KARE ÖRTME SOFT

Kod Code	KAOR0101141001
Açıklama Description	Duroplast Örtme Tak-Çıkar Yavaş Kapanan Klozet Kapağı Duroplast Wrap-Over Quick Release Soft Close Seat Cover
Renk Color	Beyaz White
Menteşe Hinge	Paslanmaz Krom Metal Stainless Steel
Bağlama Şekli Fixation Type	Üst Top
Koli Adedi Box Qty.	10 Adet 10 Pcs

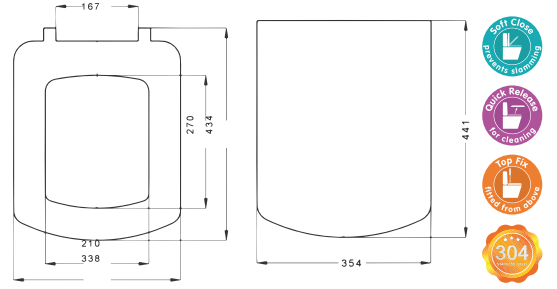

AKDENİZ SLIM SOFT

Kod Code	AKSL0101141001
Açıklama Description	Duroplast SLIM Tak-Çıkar Yavaş Kapanan Klozet Kapağı Duroplast Slim Wrap-Over Quick Release Soft Close Seat Cover
Renk Color	Beyaz White
Menteşe Hinge	Paslanmaz Krom Metal Stainless Steel
Bağlama Şekli Fixation Type	Üst Top
Koli Adedi Box Qty.	10 Adet 10 Pcs

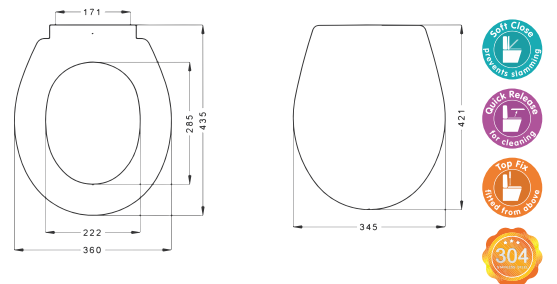

Klozet Kapağı Seat Cover



Metal Üst Ment.	475.00₺	710.00₺	710.00₺	950.00₺	1000.00₺
Pls Üst Ment.	450.00₺	675.00₺	675.00₺	900.00₺	950.00₺

Klozet Kapağı Seat Cover



Metal Üst Ment.	450.00₺	675.00₺	675.00₺	900.00₺	950.00₺
Pls Üst Ment.	475.00₺	710.00₺	710.00₺	950.00₺	1000.00₺

KARE ÖRTME

Kod Code	KAOR0101101001	
Açıklama Description	Duroplast Örtme Klozet Kapağı Duroplast Wrap-Over Seat Cover	
Renk Color	Beyaz White	
Menteşe Hinge	Paslanmaz Krom Metal Stainless Steel	Plastik Plastic
Bağlama Şekli Fixation Type	Üst Top	
Koli Adedi Box Qty.	10 Adet 10 Pcs	

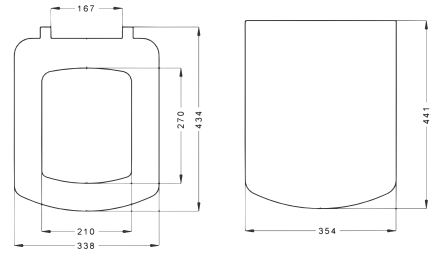

GALA PREMIUM

Kod Code	GAPR0101101001	
Açıklama Description	Duroplast SLIM Klozet Kapağı Duroplast SLIM Seat Cover	
Renk Color	Beyaz White	
Menteşe Hinge	Paslanmaz Krom Metal Stainless Steel	Plastik Plastic
Bağlama Şekli Fixation Type	Üst Top	
Koli Adedi Box Qty.	10 Adet 10 Pcs	

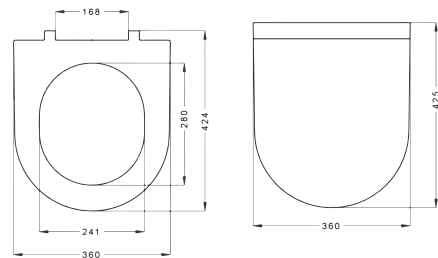

Klozet Kapağı Seat Cover

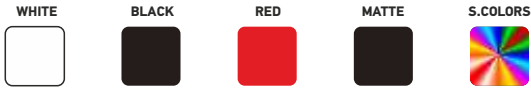

Metal Üst Ment.	475.00₺	710.00₺	710.00₺	950.00₺	1000.00₺
Pls Üst Ment.	450.00₺	675.00₺	675.00₺	900.00₺	950.00₺

Klozet Kapağı Seat Cover

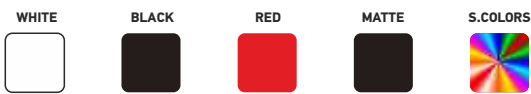

Metal Üst Ment.	475.00₺	710.00₺	710.00₺	950.00₺	1000.00₺
Pls Üst Ment.	450.00₺	675.00₺	675.00₺	900.00₺	950.00₺

GALA PRESTİJ

Kod Code	GAPJ0101101001	
Açıklama Description	Duroplast Örtme Klozet Kapağı Duroplast Wrap-Over Seat Cover	
Renk Color	Beyaz White	
Menteşe Hinge	Paslanmaz Krom Metal Stainless Steel	Plastik Plastic
Bağlama Şekli Fixation Type	Üst Top	
Koli Adedi Box Qty.	10 Adet 10 Pcs	

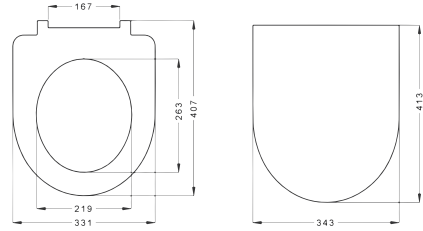

GALA ÖRTME

Kod Code	GAOR0101101001	
Açıklama Description	Duroplast Örtme Klozet Kapağı Duroplast Wrap-Over Seat Cover	
Renk Color	Beyaz White	
Menteşe Hinge	Paslanmaz Krom Metal Stainless Steel	Plastik Plastic
Bağlama Şekli Fixation Type	Üst Top	
Koli Adedi Box Qty.	10 Adet 10 Pcs	

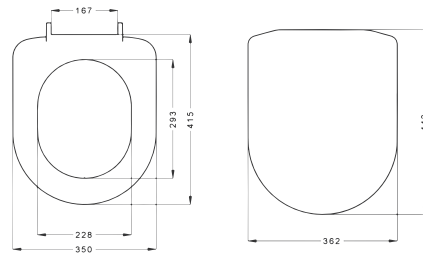

Klozet Kapağı Seat Cover



WHITE



Metal Üst Ment. **415.00₺**

Pls Üst Ment. **390.00₺**

Pls Alt Ment. **365.00₺**

Klozet Kapağı Seat Cover



WHITE



Metal Üst Ment. **390.00₺**

Pls Üst Ment. **365.00₺**

Pls Alt Ment. **340.00₺**

AKDENİZ

Kod Code	AKDZ0101101001	
Açıklama Description	Duroplast Klozet Kapağı Duroplast Seat Cover	
Renk Color	Beyaz White	
Menteşe Hinge	Paslanmaz Krom Metal Stainless Steel	Plastik Plastic
Bağlama Şekli Fixation Type	Üst Top	
Koli Adedi Box Qty.	10 Adet 10 Pcs	

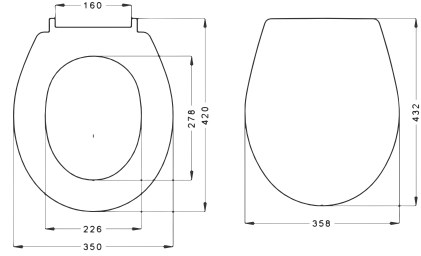

YENİ AKDENİZ

Kod Code	AKYE0101101001	
Açıklama Description	Duroplast Örtme Klozet Kapağı Duroplast Wrap-Over Seat Cover	
Renk Color	Beyaz White	
Menteşe Hinge	Paslanmaz Krom Metal Stainless Steel	Plastik Plastic
Bağlama Şekli Fixation Type	Üst Top	
Koli Adedi Box Qty.	10 Adet 10 Pcs	

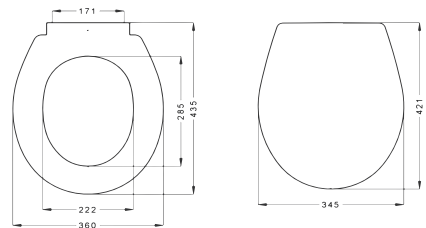

Happy Baths



www.elonebanyo.com

Klozet Kapağı Seat Cover



WHITE



Metal Üst Ment. **370.00₺**

Pls Üst Ment. **345.00₺**

Pls Alt Ment. **312.00₺**

KELEBEK

Kod Code	KLBK0101101001	
Açıklama Description	Duroplast Klozet Kapağı Duroplast Seat Cover	
Renk Color	Beyaz White	
Menteşe Hinge	Paslanmaz Krom Metal Stainless Steel	Plastik Plastic
Bağlama Şekli Fixation Type	Üst Top	
Koli Adedi Box Qty.	10 Adet 10 Pcs	

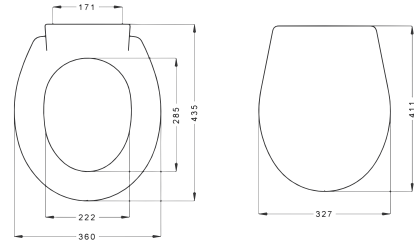

Yavaş Kapanan Klozet Kapağı Soft Close Seat Cover



WHITE



300.00₺

Yavaş Kapanan Klozet Kapağı Soft Close Seat Cover



WHITE



295.00₺

QUBE SLIM SOFT

Kod Code	QUBE0202141001
Açıklama Description	Thermoplast Tak-Çıkar Yavaş Kapanan Klozet Kapağı Thermoplast Quick Release Soft Close Seat Cover
Renk Color	Beyaz White
Menteşe Hinge	Plastik Plastic
Bağlama Şekli Fixation Type	Üst Top
Koli Adedi Box Qty.	10 Adet 10 pcs

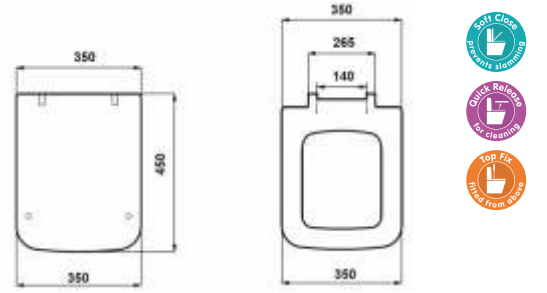

KARE SLIM SOFT

Kod Code	KASL0207141001
Açıklama Description	Thermoplast SLIM Tak-Çıkar Yavaş Kapanan Klozet Kapağı Thermoplast SLIM Quick Release Soft Close Seat Cover
Renk Color	Beyaz White
Menteşe Hinge	Plastik Plastic
Bağlama Şekli Fixation Type	Üst Top
Koli Adedi Box Qty.	10 Adet 10 pcs

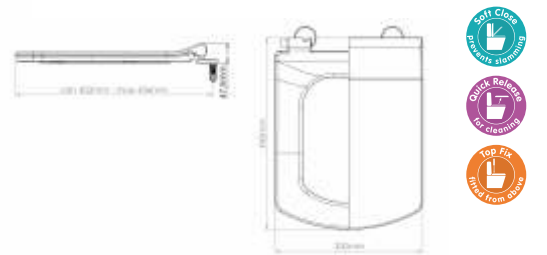

Yavaş Kapanan Klozet Kapağı Soft Close Seat Cover



WHITE



290.00₺

Yavaş Kapanan Klozet Kapağı Soft Close Seat Cover



WHITE



275.00₺

GALA SLIM SOFT

Kod Code	GASL0207141001
Açıklama Description	Thermoplast Tak-Çıkar Yavaş Kapanan Klozet Kapağı Thermoplast Quick Release Soft Close Seat Cover
Renk Color	Beyaz White
Menteşe Hinge	Plastik Plastic
Bağlama Şekli Fixation Type	Üst Top
Koli Adedi Box Qty.	10 Adet 10 pcs

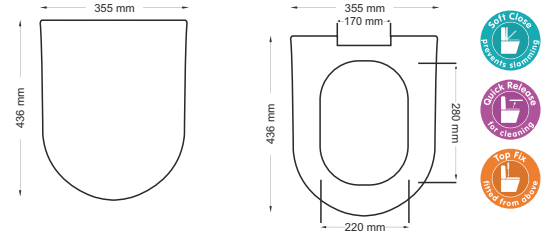

OSCAR SOFT

Kod Code	AKYE0207141001
Açıklama Description	Thermoplast Tak-Çıkar Yavaş Kapanan Klozet Kapağı Thermoplast Quick Release Soft Close Seat Cover
Renk Color	Beyaz White
Menteşe Hinge	Plastik Plastic
Bağlama Şekli Fixation Type	Üst Top
Koli Adedi Box Qty.	10 Adet 10 pcs

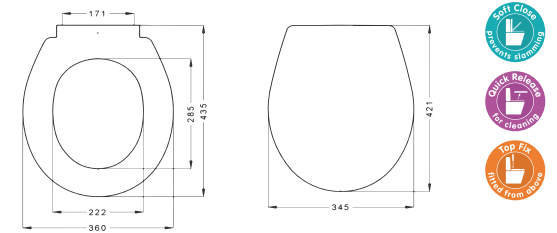

Yavaş Kapanan Klozet Kapağı Soft Close Seat Cover



WHITE



250.00₺

Yavaş Kapanan Klozet Kapağı Soft Close Seat Cover



WHITE



275.00₺

AKDENİZ SOFT

Kod Code	AKSL0203141001
Açıklama Description	Thermoplast SLIM Tak-Çıkar Yavaş Kapanan Klozet Kapağı Thermoplast SLIM Quick Release Soft Close Seat Cover
Renk Color	Beyaz White
Menteşe Hinge	Plastik Plastic
Bağlama Şekli Fixation Type	Üst Top
Koli Adedi Box Qty.	10 Adet 10 pcs

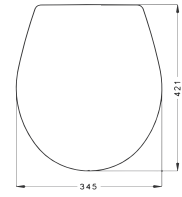
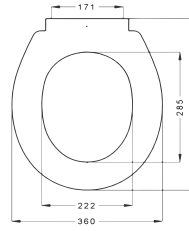

AKDENİZ KIDS SOFT

Kod Code	AKID0203141001
Açıklama Description	Thermoplast Tak-Çıkar Yavaş Kapanan Klozet Kapağı Thermoplast Quick Release Soft Close Seat Cover
Renk Color	Beyaz White
Menteşe Hinge	Plastik Plastic
Bağlama Şekli Fixation Type	Üst Top
Koli Adedi Box Qty.	10 Adet 10 pcs

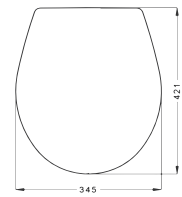
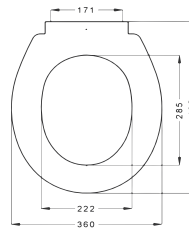

Klozet Kapağı Seat Cover



WHITE



170.00₺

Klozet Kapağı Seat Cover



WHITE



195.00₺

SOLO

Kod Code	AKYE0207121001
Açıklama Description	Thermoplast Klozet Kapağı Thermoplast Seat Cover
Renk Color	Beyaz White
Menteşe Hinge	Plastik Plastic
Bağlama Şekli Fixation Type	Üst Top
Koli Adedi Box Qty.	10 Adet 10 pcs

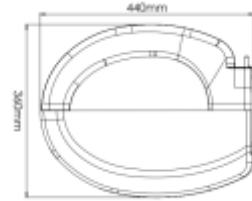

AKDENİZ

Kod Code	AKDZ0207131001
Açıklama Description	Plastik Klozet Kapağı Plastic Seat Cover
Renk Color	Beyaz White
Menteşe Hinge	Plastik Plastic
Bağlama Şekli Fixation Type	Alt Bottom
Koli Adedi Box Qty.	10 Adet 10 Pcs

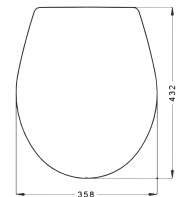
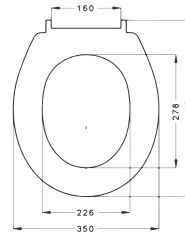

GÖMME REZERVUARLAR

Concealed Cistern

ELONE
BATHROOM ACCESSORIES

GÖMME REZERVUAR

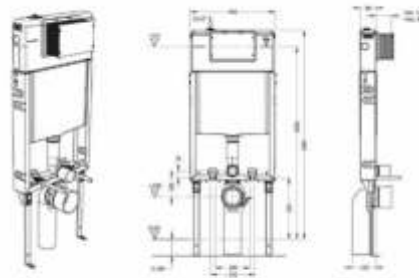
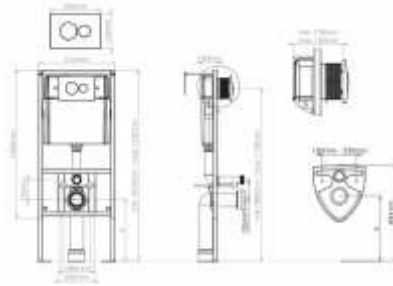
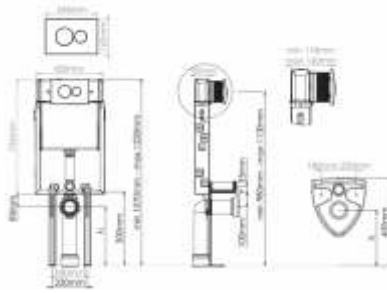

Kod Code	GOMR0102000001
Açıklama Description	Tuğla Tipi Rezervuar Concealed Cistern in Wall System for Wall Hung Closet
Koli AdetiBox Qty.	1

SET **1750.00₺**



Kod Code GOMB0202010101



Kod Code GOMB0102020401



Kod Code GOMB0201020201

Kod Code	GOMR0202000001
Açıklama Description	Alçıpan Tipi Rezervuar Concealed Cistern, Wall Mounted System, Drywall Application for Wall Hung Closet
Koli AdetiBox Qty.	1

SET **2400.00₺**



Kod Code GOMB0202010101



Kod Code GOMB0102020401



Kod Code GOMB0202010201

Kod Code	GOMB0101000001
Açıklama Description	Tuğla Tipi Rezervuar Concealed Cistern in Wall System for Wall Hung Closet
Koli AdetiBox Qty.	1

SET **2750.00₺**



Kod Code GÖMB0201030501



Kod Code GÖMB0201030201



Kod Code GÖMB0201030401



Kod Code GÖMB0201030101

İÇ TAKIM - Tek Basma

Kod Code	ICTK0101010001
Açıklama Description	Tek Basma Rezervuar İç Takım Single Push Mechanism Tüm Seramik ve Plastik Rezervuarlara Uyumlu Compatible with all Ceramic and Plastic Flush Tanks Sessiz dolum ve boşaltım Özelliği Silent Filling and Discharge Çabuk Dolum ve Ani Kapanma Quick Filling and instant Shutdown Dar Rezervuarlara Kolay Montajlama Easy mounting for narrow flush tanks
Koli Adedi Box Qty.	20 adet Kutulu - 35 adet kutusuz 20 pcs with box - 35 pcs without box

200.00₺ Kutulu

188.00₺ Poşetli



İÇ TAKIM - Çift Basma 3/6 Litre

Kod Code	ICTK0202010001
Açıklama Description	3/6 Litre Çift Basma Rezervuar İç Takım 3/6 Liter Double Push Mechanism Tüm Seramik Rezervuarlara Uyum Compatible with all Ceramic Flush Tanks Ayarlanabilir Su Seviye ile Sessiz ve Hızlı Dolum Silent and Fast Filling with Adjustable Water Level 3 yada 6 Litre Su Kullanımı İle %50 ye Varan Su Tasarrufu Water Saving Up to 50% with 3 or 6 Liters of Water Use
Koli Adedi Box Qty.	20 adet Kutulu - 35 adet kutusuz 20 pcs with box - 35 pcs without box

250.00₺ Kutulu

235.00₺ Poşetli



ELONE



FLATORLER



Kod Code	FLAT0006030001
Açıklama Description	Kompact Flatör Kompact Fill Valve
Koli Adeti Box Qty.	

105.00₺ Kutulu

95.00₺ Poşetli

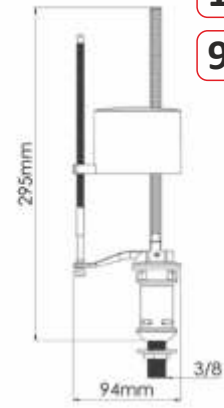

Kod Code	FLAT0007030001
Açıklama Description	Solid Flatör Solid Fill Valve
Koli Adeti Box Qty.	

205.00₺ Kutulu

192.00₺ Poşetli

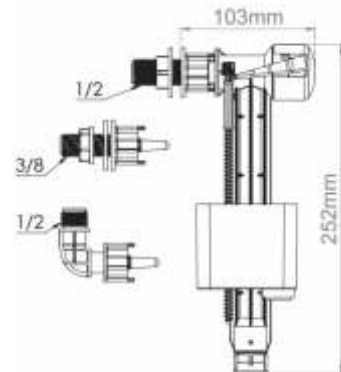

ARA KESMELER



Kod Code	AVAN0208010101
Açıklama Description	Soğuk Su Girişli Easywash Armatürü Krom Kaplama Easywash mixer with cold water entrance-chrome plated
Koli AdetiBox Qty.	30

Kod Code	AVAN0207010101
Açıklama Description	Sıcak - Soğuk Su Girişli Easywash Armatürü Krom Kaplama Easywash mixer with cold and hot water entrance-chrome plated
Koli AdetiBox Qty.	30

FİYAT SORUNUZ

Kod Code	FLT020901010101
Açıklama Description	Pirinç Filtreli Ara Musluk Brass stop valve with filter
Koli AdetiBox Qty.	30

FİYAT SORUNUZ

Kod Code	AKES0101010101
Açıklama Description	Artı Ara Kesme Artı Stop Valve
Koli AdetiBox Qty.	30

FİYAT SORUNUZ

Kod Code	AKES0201010101
Açıklama Description	Bas-Bırak Ara Kesme Press Release Stop Valve
Koli AdetiBox Qty.	30

FİYAT SORUNUZ

Kod Code	AKES0301010101
Açıklama Description	Oluklu Eko Ara Kesme Channaled Eko Stop Valve
Koli AdetiBox Qty.	30

FİYAT SORUNUZ

Kod Code	AKES0401010101
Açıklama Description	Oluklu Çubuk Ara Kesme Channaled with Rod Stop Valve
Koli AdetiBox Qty.	30

FİYAT SORUNUZ

Kod Code	AKES0501010101
Açıklama Description	Kare Ara Kesme Square Stop Valve
Koli AdetiBox Qty.	30

FİYAT SORUNUZ

Kod Code	AKES0601010101
Açıklama Description	Oluklu Ara Kesme Channaled Stop Valve
Koli AdetiBox Qty.	30

FİYAT SORUNUZ



YEDEK PARÇALAR ve MONTAJ EKİPMANLARI



Kod Code	MENT0107130002
Açıklama Description	Alttan Sıkma Plastik Menteşe Bottom Fix Plastic Hinge
Koli Adedi Box Qty.	100 Adet 100 Pcs

22.00₺



Kod Code	MENT0107120002
Açıklama Description	Üstten Sıkma Plastik Menteşe Top Fix Plastic Hinge
Koli Adedi Box Qty.	100 Adet 100 Pcs

44.00₺



Kod Code	MENT0102100002
Açıklama Description	Üstten Sıkma Metal Menteşe Top Fix Metal Hinge
Koli Adedi Box Qty.	100 Adet 100 Pcs

56.00₺



Kod Code	MENT0101150002
Açıklama Description	Düğmeli Mekanizma Button Mechanism
Koli Adedi Box Qty.	100 Adet 100 Pcs

135.00₺



Kod Code	MENT0101140002
Açıklama Description	Tak Çıkar Mekanizma Quick Release Mechanism
Koli Adedi Box Qty.	100 Adet 100 Pcs

130.00₺



Kod Code	MENT0201160002
Açıklama Description	Soft Menteşe Alt Takımı Soft Hinge Bottom Set
Koli Adedi Box Qty.	100 Adet 100 Pcs

125.00₺



Kod Code	KORK0103000002
Açıklama Description	Körüklü Kada Flexible Pan Connector
Koli Adedi Box Qty.	100 Adet 100 Pcs

55.00₺



Kod Code	EGZK0104000002
Açıklama Description	Egzantrik Kada Eccentric Pan Connector
Koli Adedi Box Qty.	100 Adet 100 Pcs

40.00₺

YEDEK PARÇALAR ve MONTAJ EKİPMANLARI

Spare Parts And Fixation Materials



Kod Code	GMON0206000002
Açıklama Description	Asma Klozet Gizli Montaj Seti Concealed fixation set for Wall Hung Closet
Koli Adedi Box Qty.	100 Adet 100 Pcs

130.00₺



Kod Code	KMON0208000002
Açıklama Description	Klozet Montaj Takımı WC Pan Fixation Set
Koli Adedi Box Qty.	100 Adet 100 Pcs

13.00₺



Kod Code	LMON0205000002
Açıklama Description	Lavabo Montaj Takımı Basin Fixation Set
Koli Adedi Box Qty.	100 Adet 100 Pcs

20.00₺



Kod Code	YMON0210000002
Açıklama Description	Yarım Ayak Yaylı Montaj Takımı Semi Pedestal fixation set
Koli Adedi Box Qty.	100 Adet 100 Pcs

20.00₺



Kod Code	LSIF0109000002
Açıklama Description	Lavabo Sifonu Körüklü ECO Metal Süzgeç Flexible Waste Pipe
Koli Adedi Box Qty.	100 Adet 100 Pcs

21.00₺



Kod Code	TCUB0106000002
Açıklama Description	Taharet Çubuğu Krom Uçlu Bidet Pipe
Koli Adedi Box Qty.	100 Adet 100 Pcs

22.00₺

YER SIFONLARI



KodCode	YSIF0101010102
Ölçü Size	100 x 100 mm
Çerçeve Frame	Paslanmaz Çelik Stainless Steel
IzgaraGrill	Paslanmaz Çelik Stainless Steel
ÇapDiameter	Ø 50mm
Çıkış Outlet	Yandan Side
Koli Adedi Box Qty.	100 Adet 100 Pcs



62.00₺



Kod Code	YSIF0102010102
Ölçü Size	100 x 100 mm
Çerçeve Frame	Plastik Plastic
IzgaraGrill	Stainless Steel Paslanmaz Çelik
ÇapDiameter	Ø 50mm
Çıkış Outlet	Yandan Side
Koli Adedi Box Qty.	100 Adet 100 Pcs



56.00₺



Kod Code	YSIF0103020102
Ölçü Size	100 x 100 mm
Çerçeve Frame	Metal Metal
Izgara Grill	Metal Metal
Çap Diameter	Ø 50mm
Çıkış Outlet	Yandan Side
Koli Adedi Box Qty.	100 Adet 100 Pcs

40.00₺



Kod Code	YSIF0203020102
Ölçü Size	150 x 150 mm
Çerçeve Frame	Metal Metal
Izgara Grill	Metal Metal
Çap Diameter	Ø 50mm
Çıkış Outlet	Yandan Side
Koli Adedi Box Qty.	100 Adet 100 Pcs

64.00₺

SERAMİK UYUMLU DUŞ KANALLARI



30cm

360°



Kod	Code	DSKA0030040001
Ölçü	Size	300 mm
Çerçeve	Frame	Seramik Uyumlu 360 ES Sifonlu Membranlı Mono Block Membrane
Izgara	Grill	Paslanmaz Stainless
Koli Adet	Box Qty.	25 Adet 50 Pcs

210.00₺

Kod	Code	DSKA0030030001
Ölçü	Size	300 mm
Çerçeve	Frame	Seramik Uyumlu 360 ES Sifonlu Mono Block 360 S Siphon
Izgara	Grill	Paslanmaz
Koli Adet	Box Qty.	25 Adet

176.00₺



30cm

360°



40cm

360°



Kod	Code	DSKA0040040001
Ölçü	Size	400 mm
Çerçeve	Frame	Seramik Uyumlu 360 ES Sifonlu Membranlı Mono Block Membrane
Izgara	Grill	Paslanmaz Stainless
Koli Adet	Box Qty.	25 Adet 50 Pcs

230.00₺

Kod	Code	DSKA0040030001
Ölçü	Size	400 mm
Çerçeve	Frame	Seramik Uyumlu 360 ES Sifonlu Mono Block 360 S Siphon
Izgara	Grill	Paslanmaz
Koli Adet	Box Qty.	25 Adet

186.00₺



40cm

360°



50cm

360°



Kod	Code	DSKA0050040001
Ölçü	Size	500 mm
Çerçeve	Frame	Seramik Uyumlu 360 ES Sifonlu Membranlı Mono Block Membrane
Izgara	Grill	Paslanmaz Stainless
Koli Adet	Box Qty.	25 Adet 50 Pcs

260.00₺

Kod	Code	DSKA0050030001
Ölçü	Size	500 mm
Çerçeve	Frame	Seramik Uyumlu 360 ES Sifonlu Mono Block 360 S Siphon
Izgara	Grill	Paslanmaz
Koli Adet	Box Qty.	25 Adet

210.00₺



50cm

360°



60cm

360°



Kod	Code	DSKA0060040001
Ölçü	Size	600 mm
Çerçeve	Frame	Seramik Uyumlu 360 ES Sifonlu Membranlı Mono Block Membrane
Izgara	Grill	Paslanmaz Stainless
Koli Adet	Box Qty.	25 Adet 50 Pcs

285.00₺

Kod	Code	DSKA0060030001
Ölçü	Size	600 mm
Çerçeve	Frame	Seramik Uyumlu 360 ES Sifonlu Mono Block 360 S Siphon
Izgara	Grill	Paslanmaz
Koli Adet	Box Qty.	25 Adet

238.00₺



60cm

360°



SERAMİK UYUMLU DUŞ KANALLARI



Kod	Code	DSKA0020020001
Ölçü	Size	200 mm
Çerçeve	Frame	Seramik Uyumlu Membranlı Mono Block Membrane
Izgara	Grill	Paslanmaz Stainless
Koli Adet	Box Qty.	50 Adet 50 Pcs

170.00%

DSKA0020010001

200 mm
Seramik Uyumlu
Mono Block

Paslanmaz

50 Adet

140.00%



Kod	Code	DSKA0030020001
Ölçü	Size	300 mm
Çerçeve	Frame	Seramik Uyumlu Membranlı Mono Block Membrane
Izgara	Grill	Paslanmaz Stainless
Koli Adet	Box Qty.	25 Adet 50 Pcs

200.00%

DSKA0030010001

300 mm
Seramik Uyumlu
Mono Block

Paslanmaz

25 Adet

166.00%



Kod	Code	DSKA0040020001
Ölçü	Size	400 mm
Çerçeve	Frame	Seramik Uyumlu Membranlı Mono Block Membrane
Izgara	Grill	Paslanmaz Stainless
Koli Adet	Box Qty.	25 Adet 50 Pcs

220.00%

DSKA0040010001

400 mm
Seramik Uyumlu
Mono Block

Paslanmaz

25 Adet

176.00%



Kod	Code	DSKA0050020001
Ölçü	Size	500 mm
Çerçeve	Frame	Seramik Uyumlu Membranlı Mono Block Membrane
Izgara	Grill	Paslanmaz Stainless
Koli Adet	Box Qty.	25 Adet 50 Pcs

250.00%

DSKA0050010001

500 mm
Seramik Uyumlu
Mono Block

Paslanmaz

25 Adet

200.00%



Kod	Code	DSKA0060020001
Ölçü	Size	600 mm
Çerçeve	Frame	Seramik Uyumlu Membranlı Mono Block Membrane
Izgara	Grill	Paslanmaz Stainless
Koli Adet	Box Qty.	25 Adet 50 Pcs

275.00%

DSKA0060010001

600 mm
Seramik Uyumlu
Mono Block

Paslanmaz

25 Adet

228.00%



ILICA



Kod Code	Krom Chrome 706030010	Mat Siyah Matte Black 706030020
Açıklama Description	Kapaklı Kağıtlık Toilet Paper Roll Holder with Cover	
Koli Adedi Box Qty.	20 Adet 20 Pcs	

290.00₺



Kod Code	Krom Chrome 706030110	Mat Siyah Matte Black 706030120
Açıklama Description	Kağıtlık Toilet Paper Roll Holder	
Koli Adedi Box Qty.	20 Adet 20 Pcs	

240.00₺

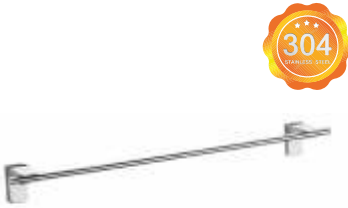

Kod Code	Krom Chrome 706031010	Mat Siyah Matte Black 706031020
Açıklama Description	Uzun Havluluk Towel Bar	
Koli Adedi Box Qty.	20 Adet 20 Pcs	

375.00₺



Kod Code	Krom Chrome 706031310	Mat Siyah Matte Black 706031320
Açıklama Description	Kağıt Havluluk Towel Holder	
Koli Adedi Box Qty.	20 Adet 20 Pcs	

350.00₺



Kod Code	Krom Chrome 706031110	Mat Siyah Matte Black 706031120
Açıklama Description	Halka Havluluk Towel Ring	
Koli Adedi Box Qty.	20 Adet 20 Pcs	

255.00₺

ILICA



Kod Code	Krom Chrome 706032110	Mat Siyah Matte Black 706032120
Açıklama Description	Çatal Bornozluk Double Robe Hook	
Koli Adedi Box Qty.	20 Adet 20 Pcs	

182.00₺



Kod Code	Krom Chrome 706033110	Mat Siyah Matte Black 706033120
Açıklama Description	Sabunluk Soap holder	
Koli Adedi Box Qty.	20 Adet 20 Pcs	

295.00₺



Kod Code	Krom Chrome 706032210	Mat Siyah Matte Black 706032220
Açıklama Description	Diş Fırçalık Tooth Brush Holder	
Koli Adedi Box Qty.	20 Adet 20 Pcs	

295.00₺



Kod Code	Krom Chrome 706034110	Mat Siyah Matte Black 706034120
Açıklama Description	Etajer Shelf	
Koli Adedi Box Qty.	20 Adet 20 Pcs	

425.00₺

HİSAR



Kod Code	706030030
Açıklama Description	Kapaklı Kağıtlık Toilet Paper Roll Holder with Cover
Koli Adedi Box Qty.	20 Adet 20 Pcs
	69.00₺



Kod Code	706030130
Açıklama Description	Kağıtlık Toilet Paper Roll Holder
Koli Adedi Box Qty.	20 Adet 20 Pcs
	52.00₺



Kod Code	706031030
Açıklama Description	Uzun Havluluk Towel Bar
Koli Adedi Box Qty.	20 Adet 20 Pcs
	95.00₺



Kod Code	706031330
Açıklama Description	Kağıt Havluluk Towel Holder
Koli Adedi Box Qty.	20 Adet 20 Pcs
	64.00₺



Kod Code	706031130
Açıklama Description	Halka Havluluk Towel Ring
Koli Adedi Box Qty.	20 Adet 20 Pcs
	70.00₺

HİSAR



Kod Code	706032130
Açıklama Description	Çatal Bornozluk Double Robe Hook
Koli Adedi Box Qty.	20 Adet 20 Pcs

57.00₺



Kod Code	706033130
Açıklama Description	Sabunluk Soap holder
Koli Adedi Box Qty.	20 Adet 20 Pcs

106.00₺



Kod Code	706033230
Açıklama Description	Diş Fırçalık Tooth Brush Holder
Koli Adedi Box Qty.	20 Adet 20 Pcs

106.00₺



Kod Code	706034130
Açıklama Description	Etajer Shelf
Koli Adedi Box Qty.	20 Adet 20 Pcs

110.00₺

ELONE
BATHROOM ACCESSORIES



ELONE

BATHROOM ACCESSORIES



+90 0530 464 40 41
+90 0541 642 75 56

www.elonebanyo.com
www.arelseramik.com
info@elonebanyo.com
info@arelseramik.com

İnköy Mh. Eskişehir Karayolu Bulvarı No:49
Merkez / Kütahya / Türkiye